



**INTERACTIVE
KISS TARGET NANO TOPPER
PINBALL MOD
for Stern Kiss Pro / Premium / LE
Version 3.0**



Thank you for your purchase and support!

TABLE OF CONTENTS

WHAT'S IN THE BOX!

1. 1 x KISS Target Nano Topper with stainless steel mounting bracket with long connection cable (Ver. 3 only) as shown below on the right
2. 1 x Lamp Board Splitter Board with Splitter cable pre-connected to J2 socket
- ~~3. 1 x Lamp Board Splitter to KISS Target Nano Topper connection cable (Ver. 1 + 2 only)~~
4. 1 Aluminium 1 ½" Hex Spacer 6/32" mount and washer
5. 2 x White Cable ties
6. 1 x Black Cable tie
7. 1 x Aero Pinball sticker

NOTE: If you have the new **KISS Target Nano Topper REVISED VERSION 3.0**, it should have a Lamp Board Splitter long connection cable for easier installation, as shown below on the right.



INSTALLATION GUIDE

- | | |
|---------------------------------------|----|
| 1. Tools Required | 2 |
| 2. KISS Ramp Nano Topper Installation | 2 |
| 3. Additional LED testing | 14 |

INSTALLATION GUIDE

1. TOOLS REQUIRED

- a) Phillips screwdriver
- b) Hex Tool (optional)

2. KISS TARGET NANO TOPPER INSTALLATION

- a) Prior commencing installation please make sure the pinball machine is completely switched off and unplugged.
- b) **REMOVE** the **Lockdown Bar**.
- c) **REMOVE** the **Playfield Glass**.
- d) **REMOVE ALL 6** pinball balls
- e) **PLEASE NOTE** the KISS Target Nano Topper pinball mod is **FRAGILE** so please **HANDLE WITH CARE**
- f) **The new REVISED VERSION 3.0** of the KISS Nano Topper, should have a Lamp Board Splitter long connection cable as shown below.



- g) Unscrew the mounting metal top screw and washer situated on LEFT PLASTIC RAMP top flap exit in the TOP LEFT UPPER CORNER PLAYFIELD (i.e. next to the Paul Stanley figure) as shown below:

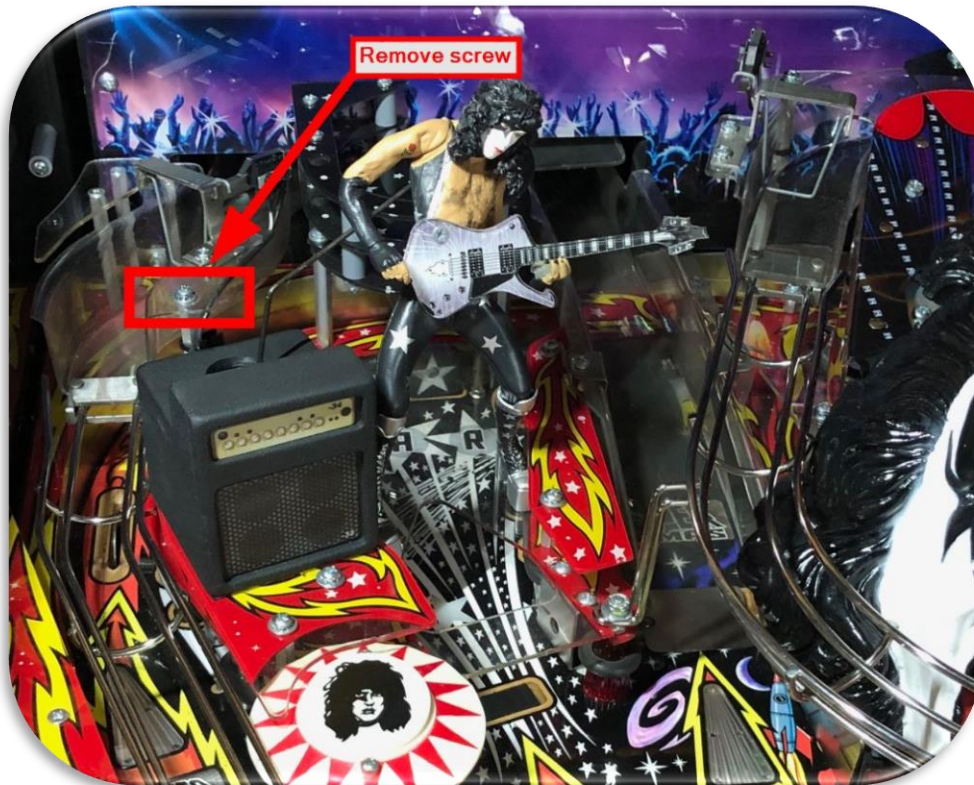

- h) **PLEASE NOTE:** Place the metal screw and washer aside in a safe place as you will need this to attach the Kiss Target Nano Topper to the aluminium metal hex spacer later.

- i) Screw the Aluminium 1 ½" Hex Spacer 6/32" mount through the supplied metal washer onto the LEFT PLASTIC RAMP TOP FLAP firmly with your hand or use a hex tool, but **DO NOT OVER TIGHTEN!**



- j) Straighten the supplied KISS Nano Topper long connection cable and at the 5 PIN WHITE MALE connector end insert through the hole in the playfield plastic, as shown below.

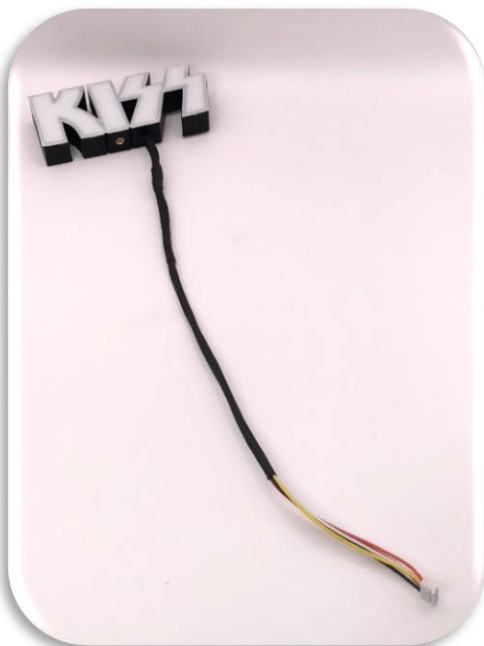

- k) Before installing the KISS Nano Topper, loosen the screw of the stainless steel mounting bracket and rotate the mounting bracket to suit your desired position as shown below. **TIP:** To position the Nano Topper close to the left side of the cabinet, rotate the bracket position as shown in the 3rd picture shown below and tighten the screw, but **DO NOT OVER TIGHTEN!** Position the nano topper as desired.

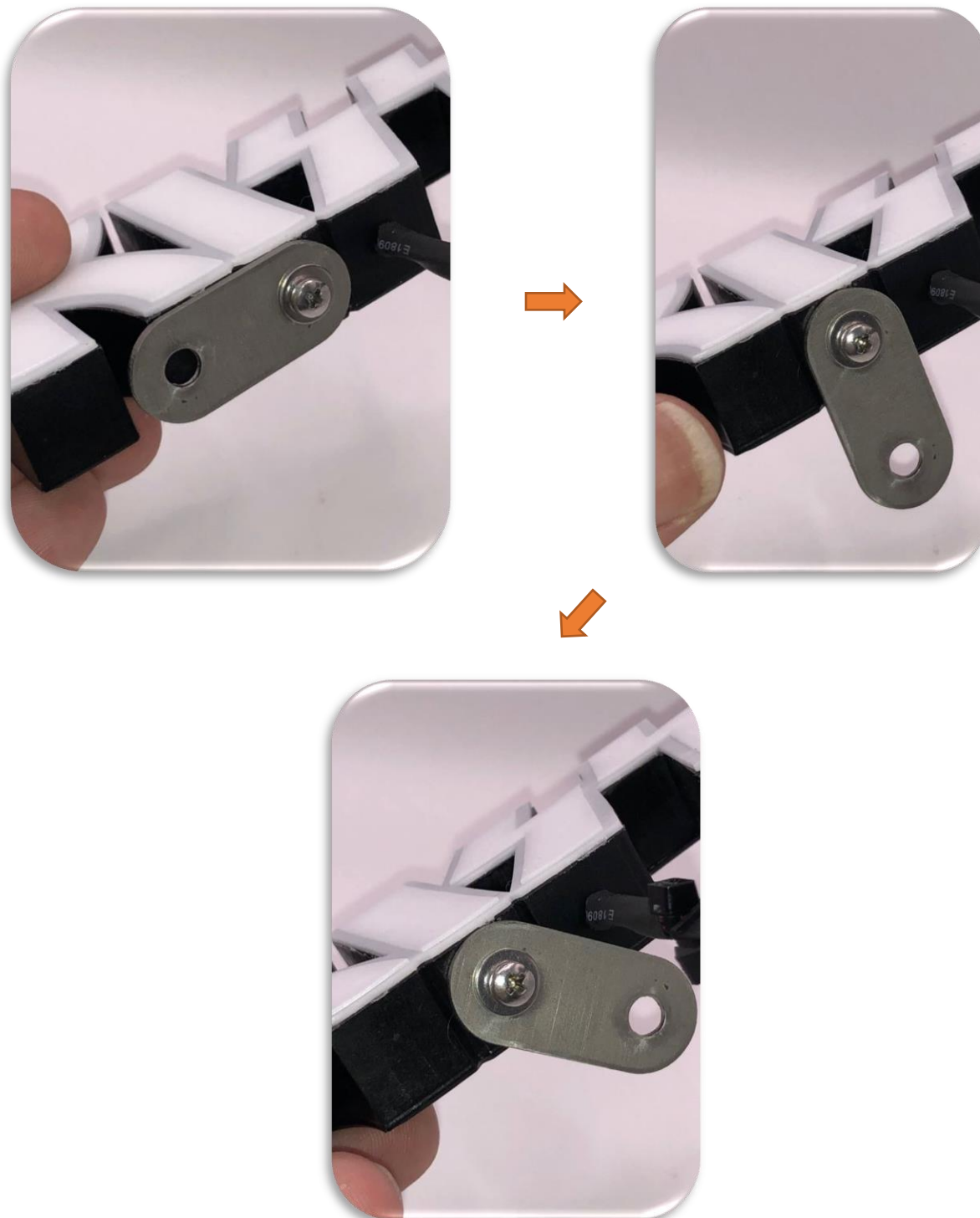

- l) Attach the KISS Nano Topper with its steel bracket to the Aluminium 1 ½" Hex Spacer and use the original metal screw and washer from step 2(h) to tighten and fix in place. Position topper as desired.

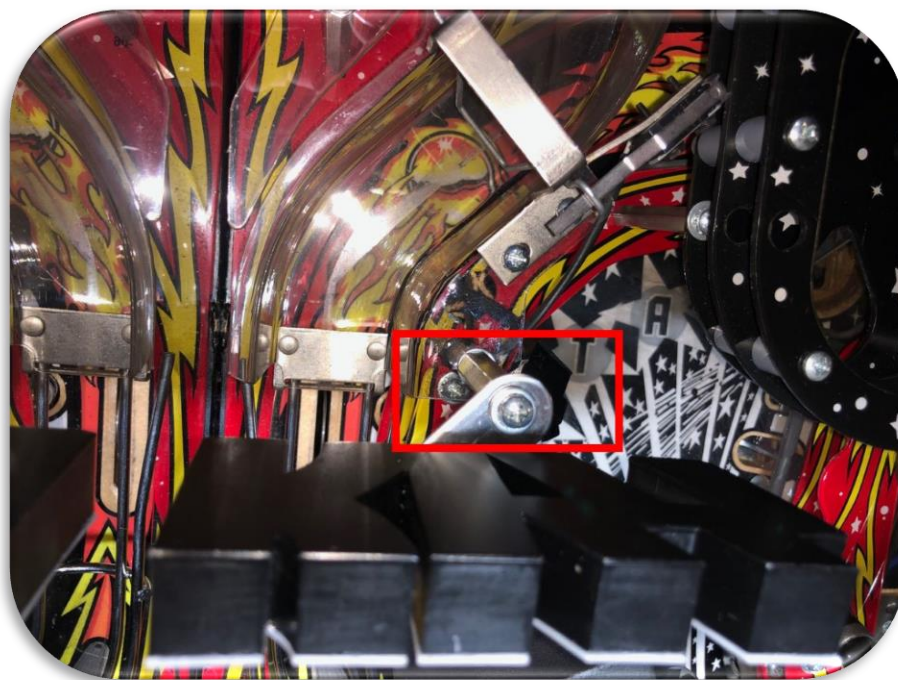

- m) Lift the Playfield carefully.
- n) Locate the NODE BOARD 11 which is found on the bottom left of the playfield as shown circled in red.

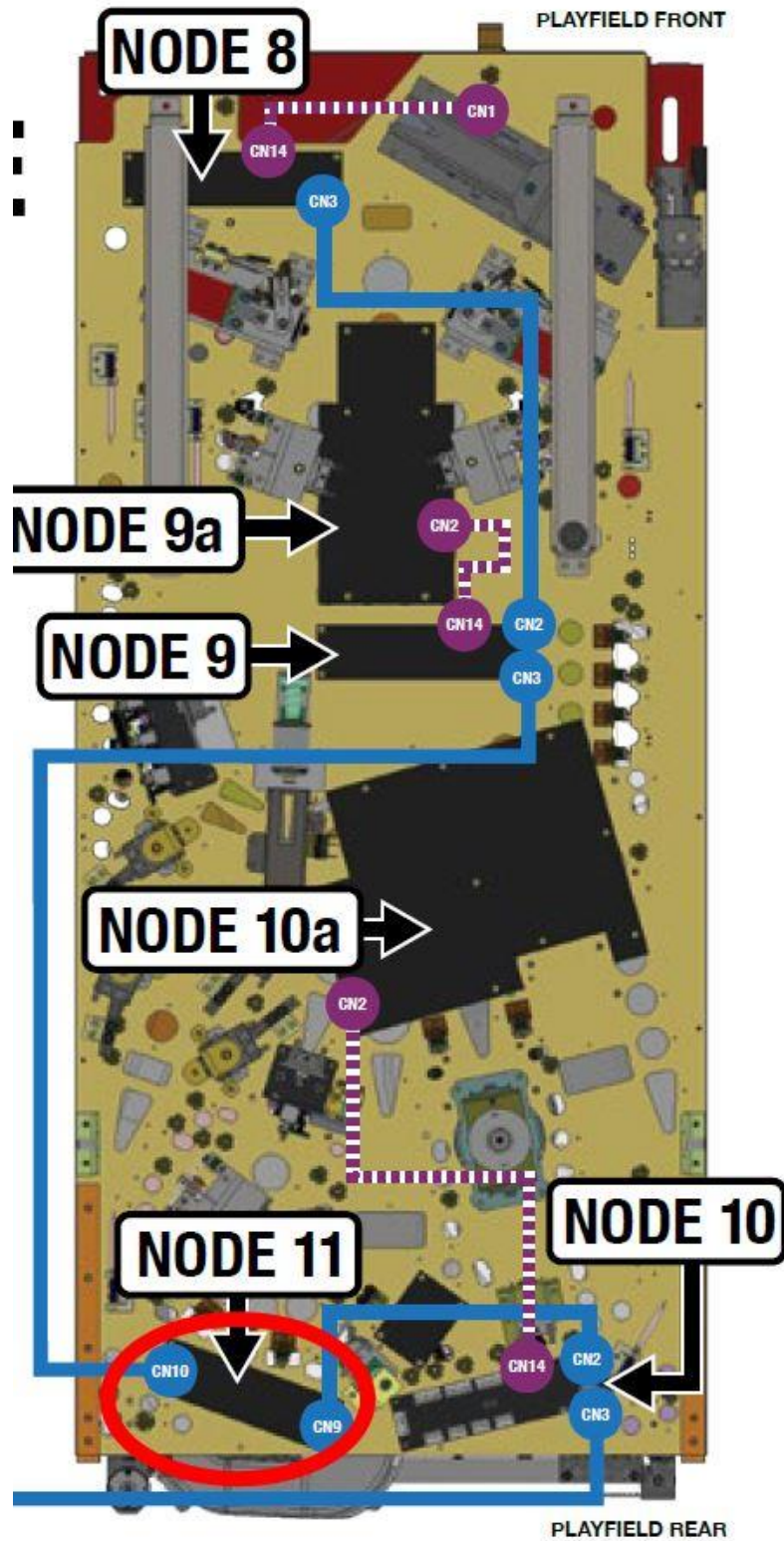

- o) At the NODE BOARD 11, **UNPLUG / DISCONNECT** the cable from **CN8 socket NEUTRAL** connection carefully as shown in the red rectangle and pic below.

4.6 NODE 11 UPPER PLAYFIELD 32-LIGHT AND SWITCH PINOUT 520-5322-00

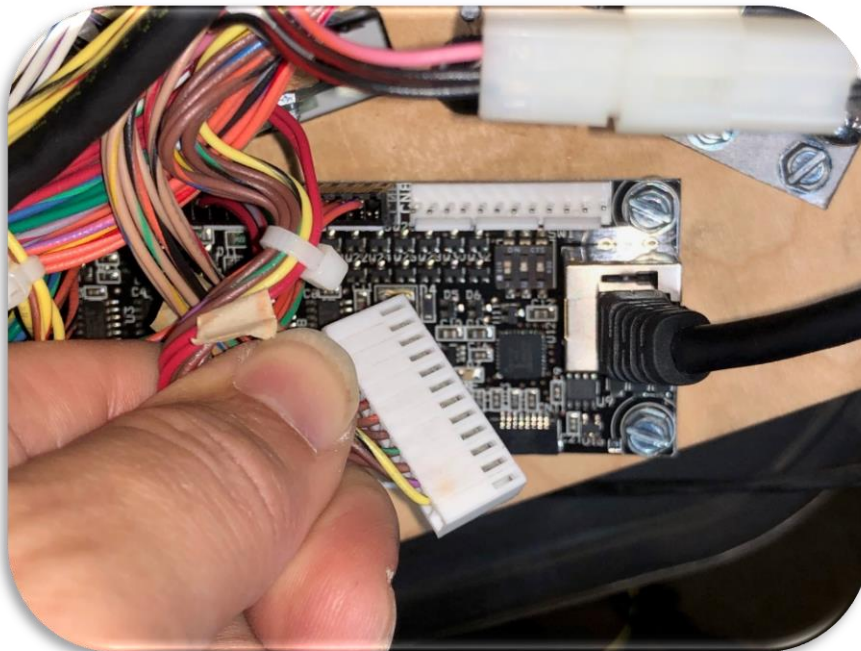
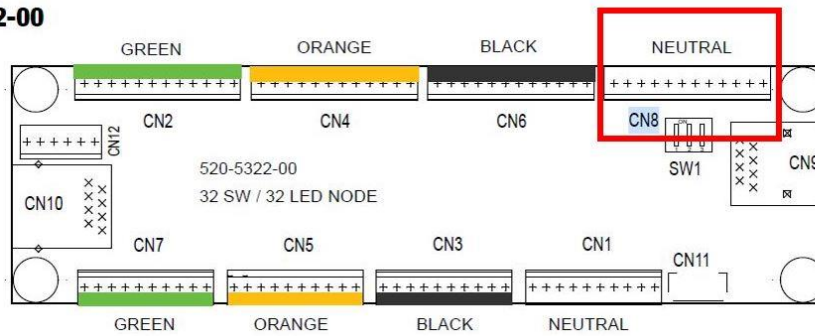

- p) Connect the playfield CN8 cable into the **J1 socket** of the Lamp Board Splitter board as shown below. **NOTE: The CN8 connector can ONLY be inserted one way as shown.**

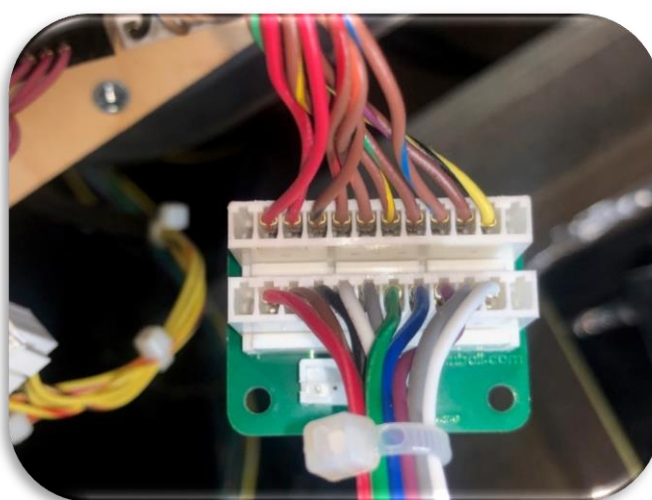
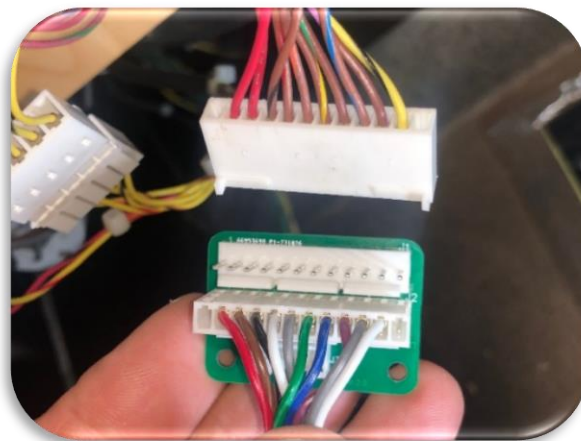

- q) Take the pre-connected cable which is connected from the **J2 socket** of the Lamp Board Splitter board and **route the unconnected end back to the CN8 socket of the Node Board 11** as shown below:

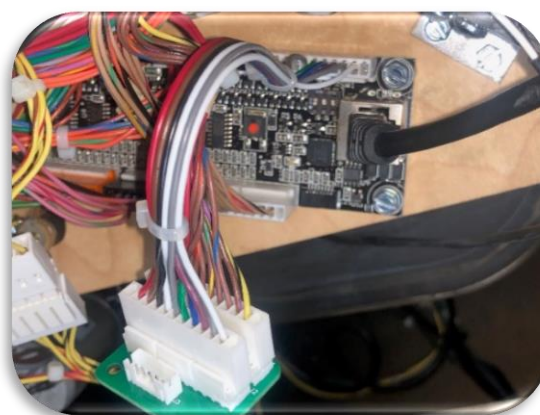
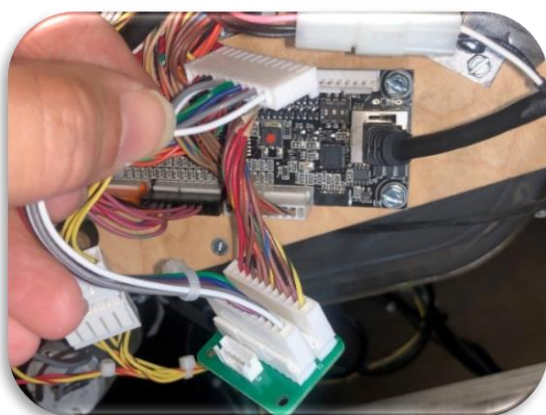

- r) Connect the **unconnected end** of the Kiss Nano Topper cable that was inserted from above the playfield in **STEP 2(j)** and connect this into **J3 socket** of the Lamp Board Splitter board.

NOTE: The J3 cable end can **ONLY** be inserted into the **J3 socket ONE WAY** as shown below:

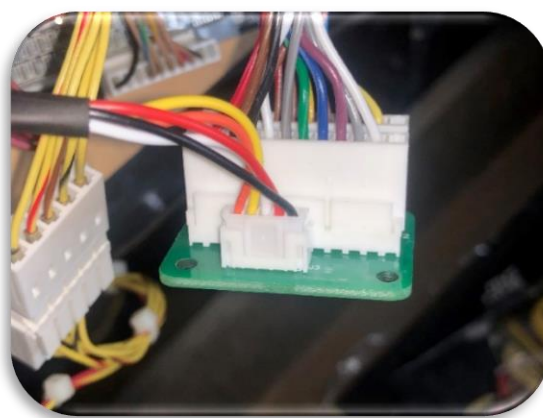
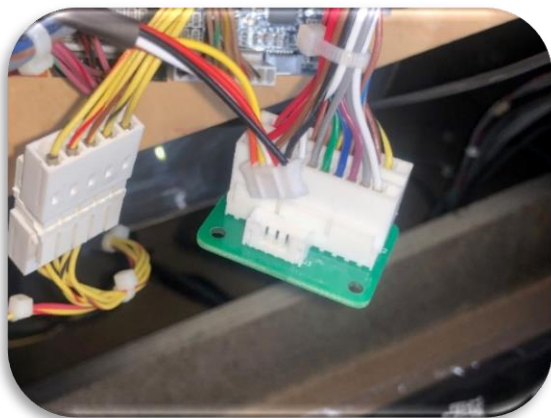

- s) Using the supplied white cable tie, tie the cables from Lamp Board Splitter board to an existing fixed wiring loom securely as show below:

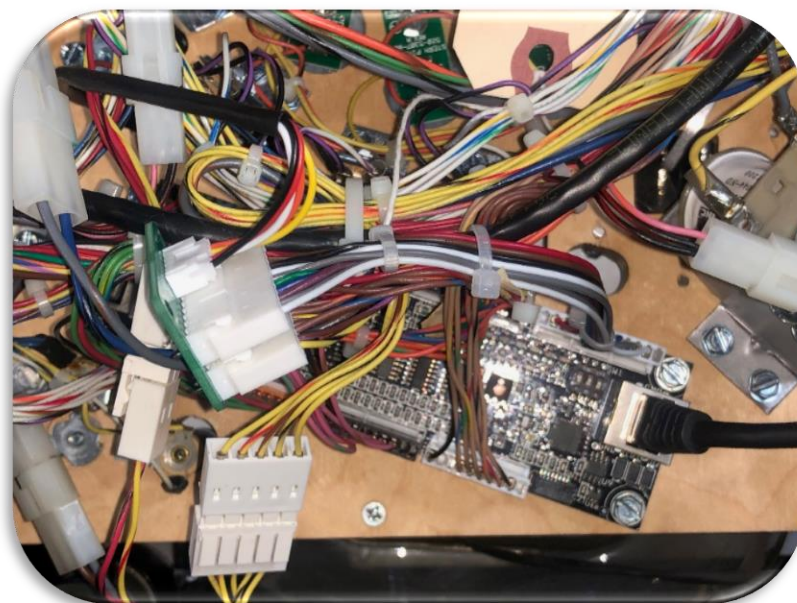
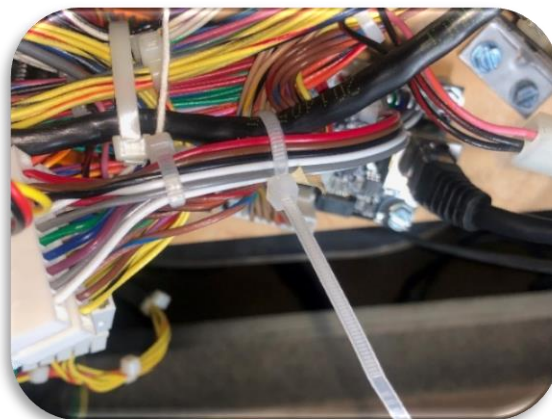
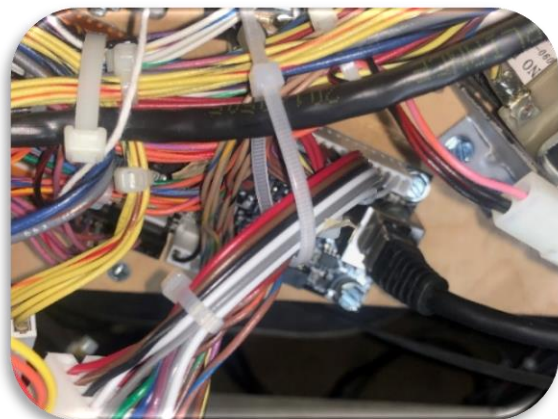

- t) **LOWER THE PLAYFIELD BACK INTO POSITION CAREFULLY.**
- u) **INSERT ALL 6** pinball balls back into the ball trough.
- v) **POWER ON** the machine while keeping the coin door closed.
- w) Once the machine is successfully powered on, the machine will commence ATTRACT MODE and you should see all lamps inserts including the KISS TARGET NANO TOPPER scrolling through the lighting sequence. The KISS TARGET NANO TOPPER should be scrolling in line with the KISS Target Lamp Inserts.
- x) At this stage if all is working, **SLIDE THE PLAYFIELD GLASS** and **LOCKDOWN BAR** back in place and **ENJOY!**



3. ADDITIONAL LED TESTING

- a) Navigate into the **DIAGNOSTIC MENU > TEST ALL LEDS** close the coin door and you should see **ALL LAMPS INSERTS FLASHING** including the **KISS TARGET NANO TOPPER**.



- b) Alternatively, to test each K, I, S, and S letters of the topper individually, navigate to the **DIAGNOSTIC MENU > SINGLE LED TEST** and select each LED number from 67 (K), 68 (I), 69 (S) and 70 (S) are lit individually as shown below:



Please reach out to aeropinball@gmail.com for installation assistance, if required.

THANK YOU FOR YOUR SUPPORT!

ENJOY!